

Article number: 20162B162SW

Description: E+G

Base plate clamp GN162-B16-2-SW

Measures

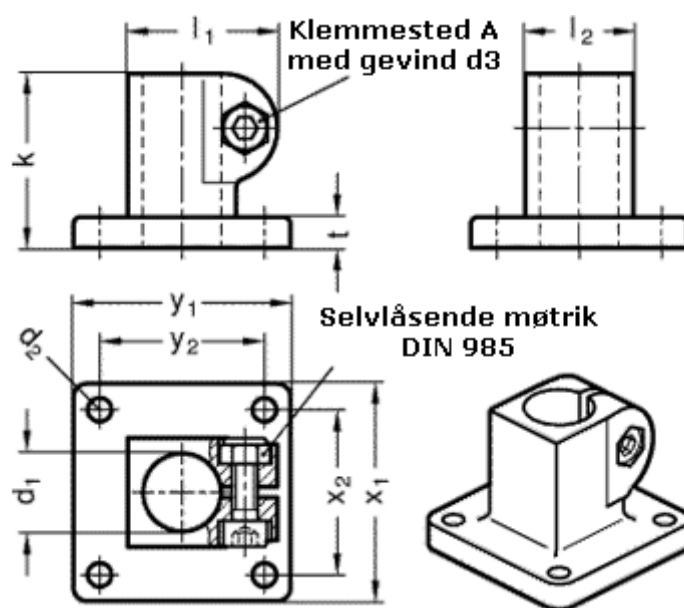

Adjustable clamp lever = GN 911-M6-22 have to be ordered separately

d1	= B16
d2	= 5.5
d3	= M 6
k	= 40
l1	= 34.5
l2	= 25
t	= 7

x1 = 50

x2 = 38

y1 = 50

y2 = 38